

freedom starts here.



CAMPERKING

AutoTrader

Highly Rated
FOR OUR
CUSTOMER
SERVICE 2023



At CamperKing, adventure isn't just a word, it's a way of life. We take the iconic VW Transporter and transform it into something more: a luxury home on wheels, built for style, comfort, and true freedom. Whether you're chasing sunsets, taking the kids to the coast, or venturing completely off-grid, a CamperKing campervan is your ticket to life without limits.

www.camperking.co.uk

out of office.



About CamperKing.

Adventure starts here.

Get on the road with the UK's leading manufacturer of VW campervan conversions. Unlike many converters, we don't outsource.

We build everything in-house, ensuring the highest standards of safety, comfort, and innovation.

We are pioneers of new product design, leading the industry with next-generation campervans like the T7 Freedom or the T6.1 Gen 2, offering advanced off-grid capability, unrivalled safety features, and smarter technology than anything else on the road today.

With an authorised dealer network across the UK, expert advice and your perfect CamperKing campervan is never far away.

Whether you want a ready-to-drive model, a fully customised build, or to convert your own VW Transporter, CamperKing makes campervan ownership simple, flexible, and more rewarding than anywhere else.

This is more than just a van. This is a **CamperKing campervan.**

We offer you the ability to **part exchange** your current motorhome, car or van against one of our campervans.

[Find out more on page 38.](#)

We work with multiple **finance partners** to assist you with flexible finance options when paying for your CamperKing campervan.

[Find out more on page 38.](#)

Our **rolling lifetime warranty** provides you with complete peace of mind when buying a CamperKing campervan.

[Find out more on page 39.](#)



Model range.



T7 Freedom.

8

CamperKing's newest campervan, offering more power and better technology than any campervan on the market today, with full off-grid capabilities and our CamperKing deluxe bed.



Le Mans.

24

Our compact but fun-loving short wheelbase Campervan is built with families and adventure in mind and comes with our CamperKing deluxe bed.



Monte Carlo & Monte Carlo Gen 2.

12

Our mid-range short or long wheelbase campervan is now available with gas or an off-grid electric inverter and our CamperKing deluxe bed.



Santorini.

28

A superb stylish long wheelbase campervan, featuring plenty of storage, a wine rack and our CamperKing deluxe bed.



St Tropez.

18

Our top-selling conversion with our CamperKing deluxe bed, extra storage options and the choice of either short or long wheelbase layouts.



Pursuit 2 & 4.

32

Our two or four berth campervan can also seat up to eight and bridges the gap between the popular Volkswagen Kombi and our other campervans.

Model comparison.

CamperKing has six campervan models to choose from, as well as our new Volkswagen T7 day van model, Freedom. They vary between short or long wheelbase Volkswagen Transporter vehicles.

For more detailed information – including video explanations of each model – visit www.camperking.co.uk



Control all your campervan's key functions from one convenient place



Built in hobs make it simple to rustle up a brew up a tea or coffee as soon as you park up



A sliding full-width bed and rail floor system are key features of our Pursuit model



Plenty of fridge and freezer space to keep food fresh



Wireless charging to keep your mobile topped up while on the move



Plenty of room to stow away food and crockery

	Pop-top roof	On-board freshwater tank & electric pump	Available in LWB	Available in SWB	CamperKing deluxe bed	Mobiframe 3 seater bed on rails	ISOFIX	Fridge freezer	Microwave	Combi sink & double hob unit	Combi sink & single hob unit	Separate sink	Gas hob	Induction hob	Power management system 12V & 240V	Internal touch LED lighting system	Wine rack	Solar panel & inverter (as standard)	Upright umbrella storage	Wireless charging pad	
T7 Freedom	👑	60l tank	👑	👑	👑	-	👑	👑	👑	-	-	👑	-	👑	👑	👑	👑	👑	👑	👑	👑
Monte Carlo Gen 2	👑	20l tank	👑	👑	👑	-	👑	👑	👑	-	-	👑	-	👑	👑	👑	-	👑	👑	👑	👑
Monte Carlo	👑	20l tank	👑	👑	👑	-	👑	👑	👑	👑	-	-	👑	-	👑	👑	-	-	👑	👑	👑
St Tropez	👑	20l tank	👑	👑	👑	-	👑	👑	-	👑	-	-	👑	-	👑	👑	-	-	👑	👑	👑
Le Mans	👑	20l tank	-	👑	👑	-	👑	👑	-	-	👑	-	👑	-	👑	👑	👑	-	👑	👑	👑
Santorini	👑	20l tank	👑	-	👑	-	👑	👑	-	👑	-	-	👑	-	👑	👑	👑	-	👑	👑	👑
Pursuit 2 & 4	Pursuit 4 only	60l tank	👑	👑	-	👑	👑	-	-	-	-	-	-	-	👑	👑	-	-	-	-	-

For more detailed information – including video explanations of each model – visit www.camperking.co.uk

The new CamperKing Freedom.

An iconic campervan reimagined for a new generation

Built on the all-new VW Transporter T7

Power, comfort, and innovation

Experience self-generating off-grid power, hot water on demand, and flexible seating for five or more.

All delivered in as little as five weeks.

The Freedom is crafted on Volkswagen's seventh-generation Transporter (T7) backed by the VW 5+ Promise, which includes:

- 5-year / 124,000-mile manufacturer's warranty
- 5 years of scheduled servicing
- 5 years of roadside assistance
- 3 MOTs covering the first five years

Plus, enjoy CamperKing's rolling lifetime warranty for complete peace of mind.



Freedom SWB key features

- 120w solar panel
- Elevating pop-top roof with panoramic safari tent, fly screens & fixed window
- CamperKing roof frame retaining B-pillar & airbags for maximum safety
- Roof bed with 2" luxury mattress & safety net
- Rail floor system with CamperKing deluxe ISOFIX bed
- Smart energy power system featuring:
 - 300Ah lithium battery (upgradeable to 1000Ah)
 - 3kw inverter for 240V off-grid power
- Dimmable interior lighting
- Wireless charging pad
- Smart control panel with app access & remote diagnostics
- 60 litre internal water tank with high-pressure rear activity shower
- 50 litre fridge/freezer
- Induction hob
- 700W microwave
- Diesel heater.

The CamperKing Freedom - freedom redefined.

Conversion specification

- Pop-top roof & sleeping comfort
- Elevating safari roof with fly screens & fixed window, bringing the outside in.
- Safer by design: CamperKing roof frame retains the 'B' pillar & airbags
- Smooth, ergonomic roof latch
- Roof bed with a luxury 2" mattress, safety net & privacy hatch.

Seating & safety

- Versatile rail floor system with CamperKing 3 seater bed featuring ISOFIX as standard. Bed safety is ECER14 certified
- Smart power & off-grid living
- CamperKing smart energy system with 300Ah lithium battery & smart monitoring
- 3kw inverter for 240V power off-grid
- 120W Shadowflux solar panel for sustainable energy
- Dimmable LED interior lighting
- Multiple power outlets: 12V, USB, USB-C & 240V
- Wireless charging pad
- Smart control panel with app access & remote diagnostics.

Kitchen & water

- Cold water sink & waste outlet (hot water upgrade available)
- 60 litre internal water tank with high-pressure rear shower
- 50 litre fridge/freezer
- Induction hob (upgrade to double available)
- 700W leisure-grade microwave (durable, no glass tray).

Comfort & privacy

- Webasto diesel heater for all-season warmth.
- VanShades blinds for style, privacy & insulation.

Optional extras

- LWB conversion extension
- Induction hob upgrade
- Off-grid hot water system
- Nomad pack (battery 500Ah upgrade)

- EverPower pack (battery 2 x 500Ah & 240W solar upgrade)
- Driver & passenger swivels
- Jump seats for additional passengers (max 2 extra seats)
- Trail pack - windscreen blinds, hook up cable, electric kettle, toaster & 10 litre water carrier.
- Porta Potti 335 Theford.

SWB

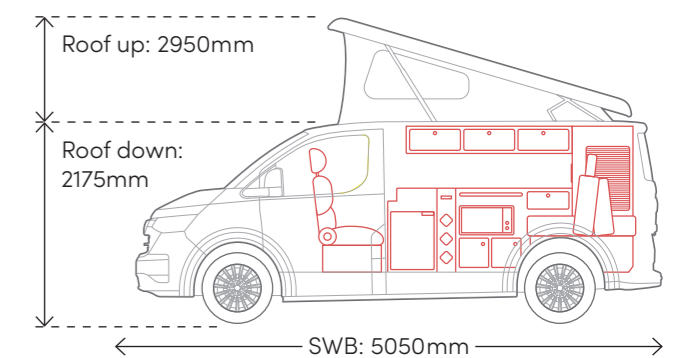
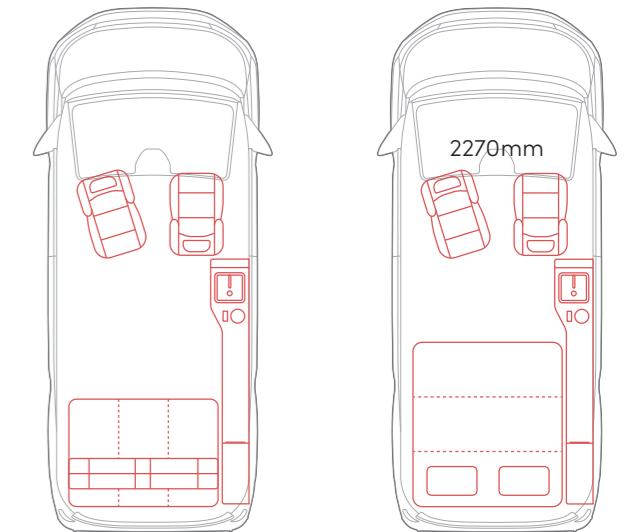

T7 Freedom.

SWB

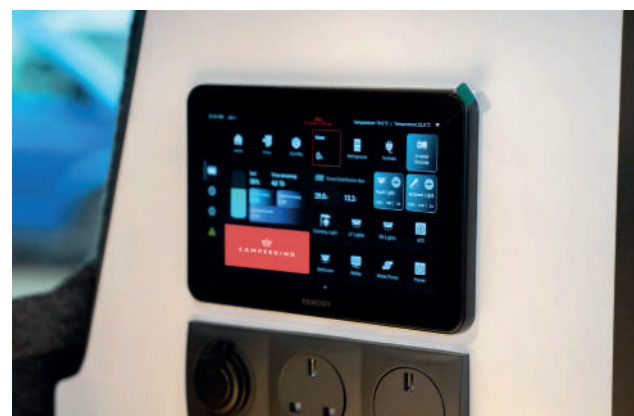

“At CamperKing we immediately felt a sense of consistent quality and professionalism”

Paul Baker



Monte Carlo & Monte Carlo Gen 2.

Our mid-range bestseller

The Monte Carlo 5 seater offers an excellent balance between comfort and practicality, featuring our CamperKing deluxe bed, double gas hob, microwave and fridge freezer.

Our new Monte Carlo Gen 2 is for those who want the option to go totally off-grid. The electric inverter supports an induction hob and wireless charging, as well as the microwave and fridge freezer.

Both are available on a short or long wheelbase.

- Seats 4 or 5 people with ISOFIX
- Pop-top roof
- CamperKing deluxe bed
- Ambient lighting
- 50 litre fridge/freezer
- Wireless charging pad
- Sink & double hob unit
- Integrated microwave
- Swivelling passenger seat
- Touch LED lighting
- Multi storage lockers

Gen 2 also includes:

- Electric induction hob
- Self generating off-grid power with a 300 amp battery.
- 120W solar panel.



SWB

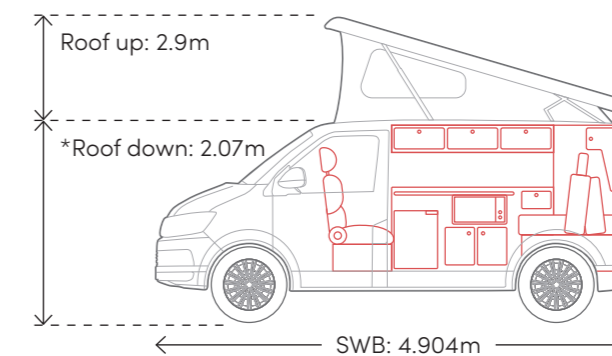
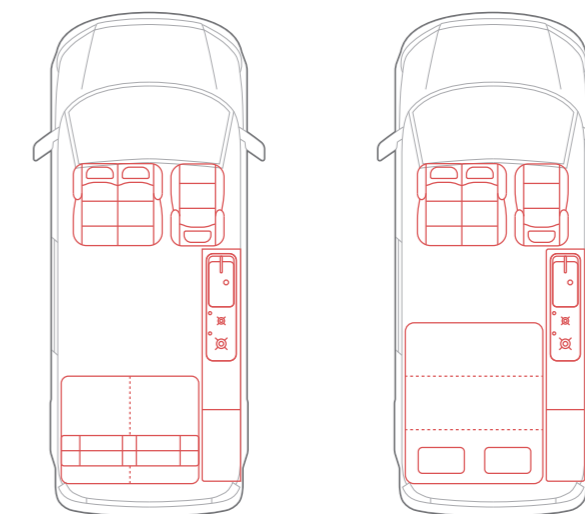

LWB

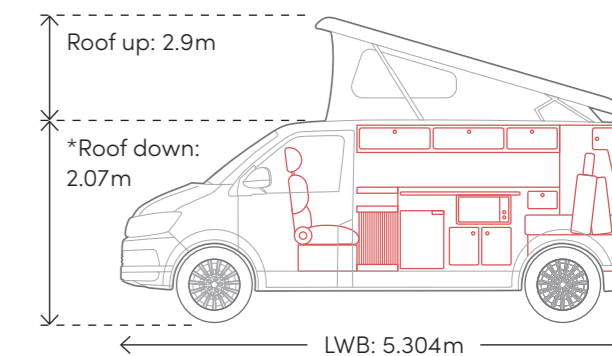
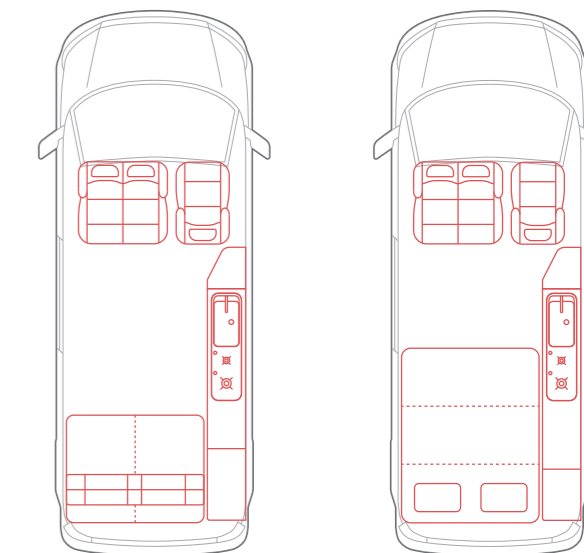

*The drawings above are of the Monte Carlo. The Monte Carlo Gen 2 is 2.12m high with the roof down due to the solar panel.

Monte Carlo Gen 2.

SWB



"I'm a recent widow, so was nervous of making this step, but I needn't have been."

Olwen



Monte Carlo.

LWB



“CamperKing really are the best! I’ve spent 4/5 months going around looking at different vans and companies, but once we went to CamperKing the price and quality was just right. They had vans for everyone in every shape and style too.”

Nathan on Trustpilot

St Tropez.

When adventure meets practical.

A customer favourite

With plenty of storage and a tried-and-tested layout that balances practical living with a family-friendly setup, it's easy to see why the St Tropez is so popular. Available on either a short or long wheelbase.

- Seats 4 or 5 people with ISOFIX
- Pop-top roof
- CamperKing deluxe bed
- Multi-point tables
- Swivelling passenger seat
- Sink & double hob unit
- 50 litre fridge/freezer
- Wireless charging pad
- Touch LED lighting
- Multi storage lockers
- Upgrades include projector, bike rack, swivel seat, solar panel.



SWB

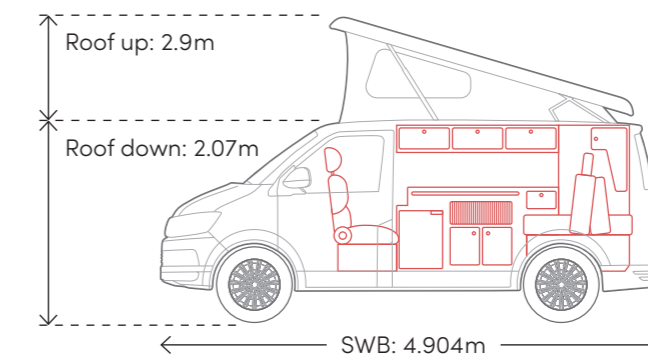
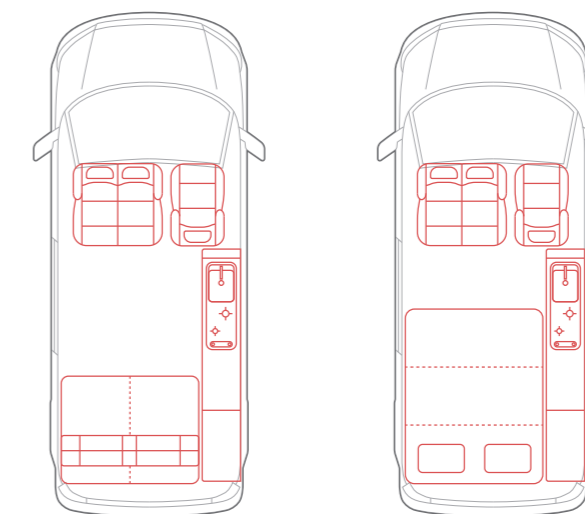

LWB

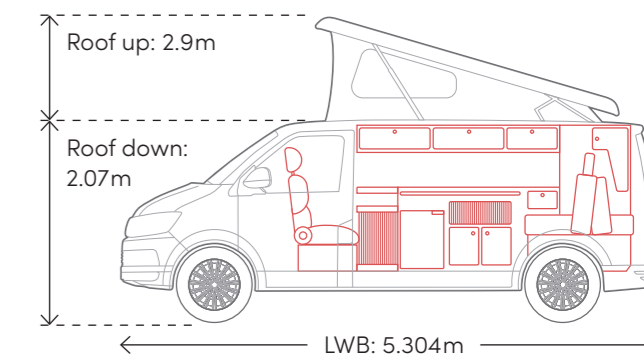
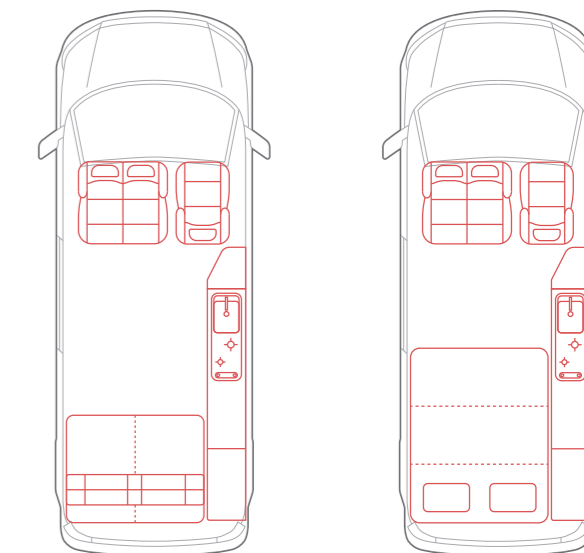

St Tropez.

SWB



“Great experience buying our first camper at CamperKing. From beginning to end help and advice.”

Tim Frost

St Tropez.

LWB



"This is our 1st Campervan and the entire process was absolutely brilliant. I cannot fault CamperKing. Great service by all."

Dean Searle



Le Mans.

The ultimate family campervan adventure-ready. Family-approved.

The Le Mans is CamperKing's all purpose campervan, perfectly designed for families on the go. Built on the short wheelbase VW Transporter, it's easy to drive, effortless to park, and ready for everything from the school run to a weekend escape.

Whether it's beach days, countryside breaks, or city stopovers, the Le Mans makes family life on the road feel effortless.

- Seats five or six people with ISOFIX
- CamperKing deluxe bed
- Sink & gas hob combination
- Full camper facilities
- Pop-top roof
- Touch LED lighting
- 50 litre fridge/freezer
- Individual coffee tables
- Swivelling passenger seat
- Wireless charging pad
- Wine rack.



SWB

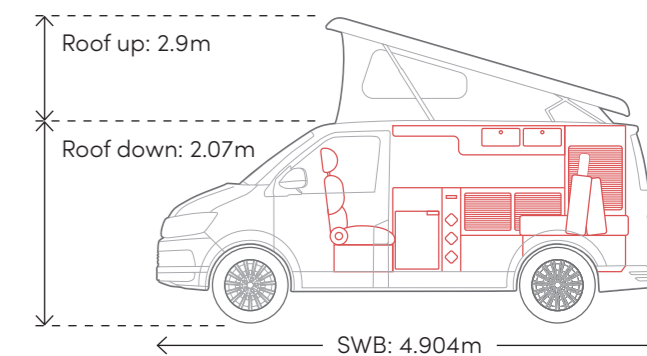
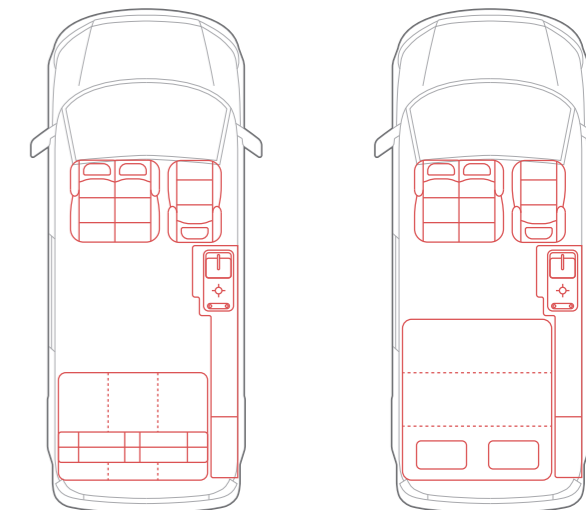

Le Mans.

SWB

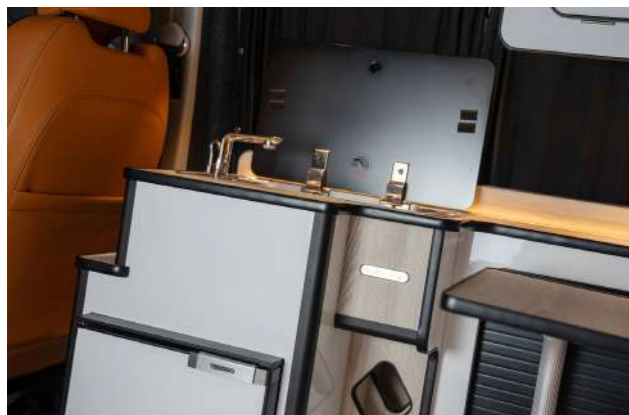

“We are thrilled to bits with the van. Way more storage than we realised. Copes easily with our family of four, fully loaded for the week”

CrewsyTsixpointone



Santorini.

Spacious, stylish, and family-ready

The Santorini is CamperKing's premium family campervan designed for modern adventurers who want space, style, and top-notch comfort. Built on the long wheelbase Volkswagen Transporter, this van offers six travel seats and the CamperKing deluxe bed with ISOFIX for safe and easy child seat fitting.

Whether you're hitting city streets or exploring the countryside, the Santorini delivers space, convenience, and all the premium features your family needs for unforgettable journeys.

- Seats 5 or 6 people with ISOFIX
- CamperKing deluxe bed
- Twin swivel front seats
- Sink & double gas hob
- Wireless charging pad
- Touch LED lighting
- 50 litre fridge/freezer
- USB, 3-pin & 12V sockets
- Custom exterior colours & alloy wheels
- Pop-top roof.



LWB

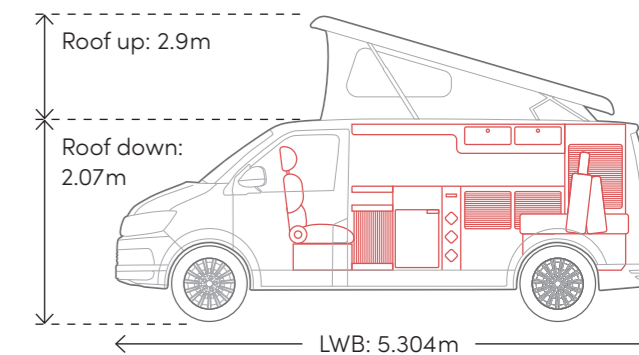
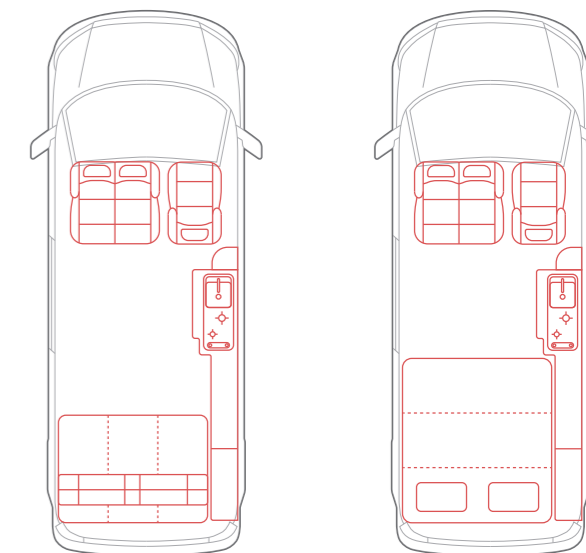

Santorini.

in LWB



“Their aftersales support is superb and they’ll even go the extra mile to help even remotely”

Amanda Willis



Pursuit.

Built for adventure

The CamperKing Pursuit day van bridges the gap between a VW Transporter Kombi van and a VW Transporter campervan.

Designed for adventure and equipped for off-grid travel, the Pursuit is the ultimate companion for your hobbies, work life and daily needs. It provides up to eight seats and offers a huge amount of space to carry camping and sports gear.

Three 60Ah lithium batteries keep the campervan powered up while the full-width three-seater bed that sits on a rail floor system, can be easily moved for a comfortable night's sleep. Available as both a long or short wheelbase campervan.

The **Pursuit 2 day van** is a two berth campervan without a pop-top roof, the option of a roof rack system and the capability to accommodate a roof tent.

The **Pursuit 4 day van** is a four berth campervan with a pop-top roof and an elevating platform bed.

- Frontrunner slimline roof rack system options
- Customisable modular layout
- Full-width 3 seater mobiframe rear bed
- Pop-top roof with bed (Pursuit 4 only)
- High-pressure shower system
- 60 litre underslung fresh water tank
- Upgrades include hot water, a diesel heater and swivelling front seats.



SWB

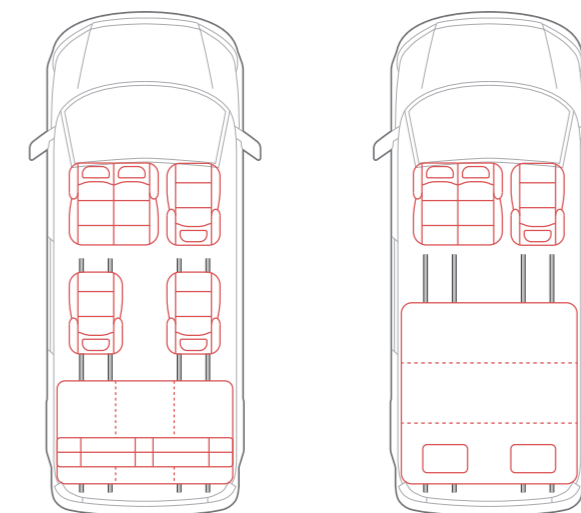

Roof down: 2.07m

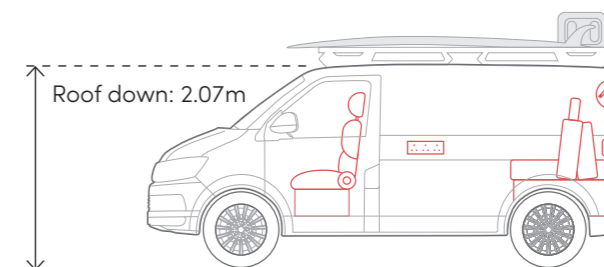

*Roof up: 2.9m

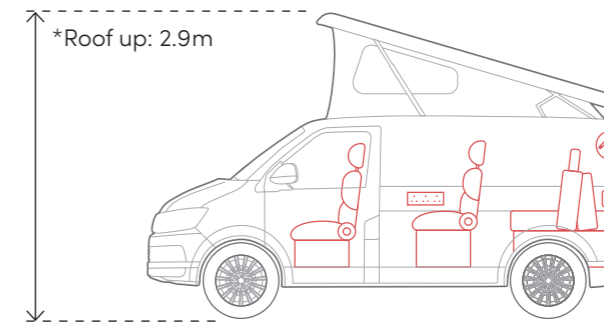

SWB: 4.904m

LWB

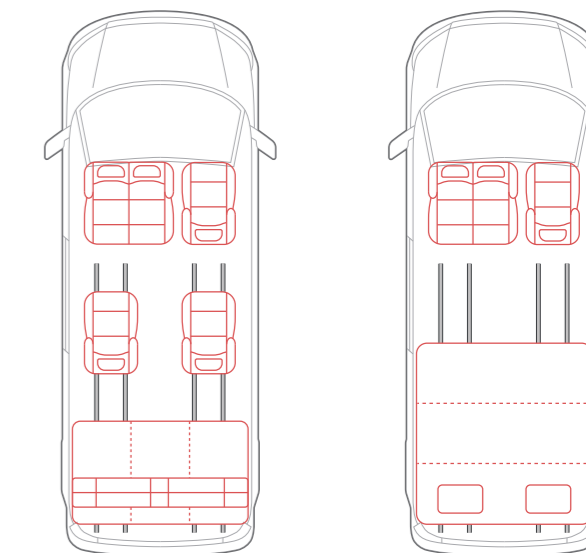

Roof down: 2.07m

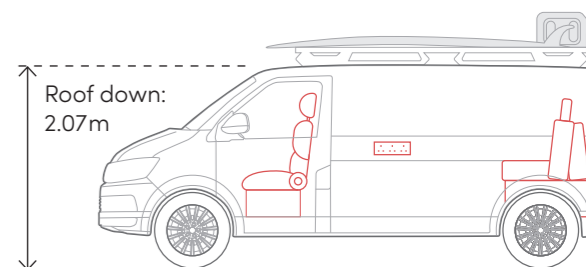

*Roof up: 2.9m

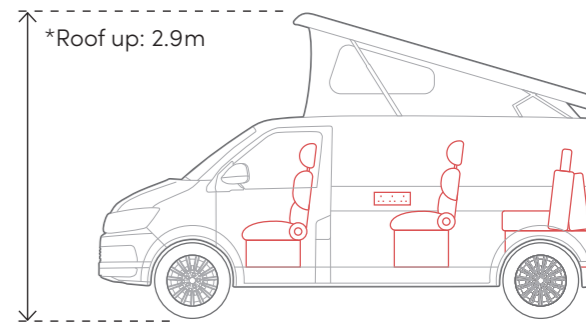

LWB: 5.304m

*Pop-top roof only available on Pursuit 4.

Pursuit 2.



“To help narrow down a very big field of van conversions we found CamperKing’s website amazing”

Michelle



Pursuit 4.

with pop-top roof



“When making a big financial commitment it’s genuinely nice not to be forced into anything and deal with such great people”

Scott Truelove





Part exchange

We are happy to offer part exchange on your current car, motorhome, van, caravan or motorbike, against one of our campervans.

Part exchange is a hassle-free way to get the best price for your current vehicle and use the proceeds of the sale towards the purchase price of a campervan. Campervans make an excellent household vehicle, being versatile enough to use for the weekly shop, the school run or even your daily commute to work.



Finance options

Making your dream CamperKing adventure a reality is easier than you think.

We work with a range of trusted finance partners to help you spread the cost of your new campervan.

With a Hire Purchase (HP) agreement, you can borrow from £2,500 and choose repayment terms from 2 to 15 years. Enjoy fixed interest rates and set monthly payments, so you can plan your budget with confidence.

This is an ideal option if you want to own your campervan outright at the end of the term, with no large final payment, just simple, predictable finance that fits your lifestyle.



CamperKing warranty

Our **CamperKing 12 month rolling lifetime warranty** provides you with complete peace of mind on all CamperKing conversions.

Simply keep up your annual habitation check with us, and your cover will continue year after year - available at our CamperKing branches in Banbury, Sutton and Newcastle.

This is in addition to any vehicle warranty attached to your campervan. This is usually the balance of Volkswagen's three year warranty on models up to T6.1 and a five year warranty on the new T7, as well as breakdown cover from the date of the vehicle's first registration.

Add your own touch

Do you want your campervan to be an extension of you?

With CamperKing you can personalise your campervan in numerous ways. From lift kits and lowered suspension, internal trim, to bike-racks, we can help you make your campervan truly unique, and a reflection of your own personality. The possibilities are endless.



Why choose CamperKing?



Buy a ready-made campervan.

At our showrooms in Warrington, North Shields and Sutton, we have a forecourt full of campervans for you to choose from. They are all ready and waiting to be driven away, so your next adventure could be nearer than you think.

Build your own.

If you'd rather choose the exact vehicle and build specification of your campervan, opt for our built-to-order service, where you can select everything from the vehicle colour to the design embossed in the upholstery. It's the very best way to ensure you get exactly what you want.

All our campervan conversions are built in-house by skilled UK craftsmen and offer an unbeatable range of campervan layouts, interiors and finishes.

Supply your own van.

Already own a Volkswagen Transporter or thinking about buying one?

Talk to CamperKing first to make sure it's the right specification for your dream conversion.

Once your van's ready, we can transform it into any model from our CamperKing range complete with water systems, electric and gas appliances, and stylish fitted furniture all in as little as four weeks.

Your van. Your vision. CamperKing craftsmanship.

About the base vehicle.

It's your choice.

At CamperKing we use three Volkswagen Transporter vans for conversion, the Panel Van, the Kombi and the Shuttle. In our T6.1 vans we offer two main specifications Startline and Highline:

T6.1 van & conversion specification

Startline

- 6.5" touchscreen with DAB+, Bluetooth & App-Connect
- Power steering & multi-function steering wheel
- LED interior lighting
- Electric windows & heated mirrors
- Full electronic stability & safety systems
- Remote central locking & alarm
- Optional business pack: adds rear parking sensors, cruise control & air conditioning

Highline

In addition to Startline plus

- Adaptive Cruise Control (ACC)
- Front & rear parking sensors
- Heated, foldable mirrors
- Automatic headlights & rain-sensing wipers
- Climatic air conditioning
- Heated front windscreen
- Body-coloured trim details

T7 van specification

VW Commerce

- Euro 6 ULEZ compliant
- 13" touchscreen infotainment system
- Bluetooth connectivity with App connect
- Cruise control & multi-function steering wheel
- Rear parking sensors
- Heated wing mirrors
- Lane assist & dynamic road sign display
- High beam control
- Keyless start
- LED headlights

VW Commerce Plus

In addition to Commerce

- Body coded bumpers & wing mirrors
- Front & rear parking sensors
- Reversing camera
- Leatherette multi-function steering wheel
- VW alarm

VW Commerce Pro

In addition to Commerce Plus

- Adaptive cruise control
- Heated seats
- 16" alloy wheels
- Power folding wing mirrors
- Heated windscreen
- Wireless mobile phone charging

SWB & LWB dimensions

SWB: 5050mm length (5.05 metres)

LWB: 5450mm length (5.45 metres)

We are able to convert the following vans into campervans



VW Transporter T7 van



VW Transporter Shuttle van



VW Transporter Kombi van



VW Transporter Panel van

The CamperKing network.

Come visit us.

We have three main dealerships - our Banbury HQ, Newcastle and Surrey, as well as easy nationwide access to our CamperKing campervans through our trusted dealer network.

Our showrooms are open seven days a week.

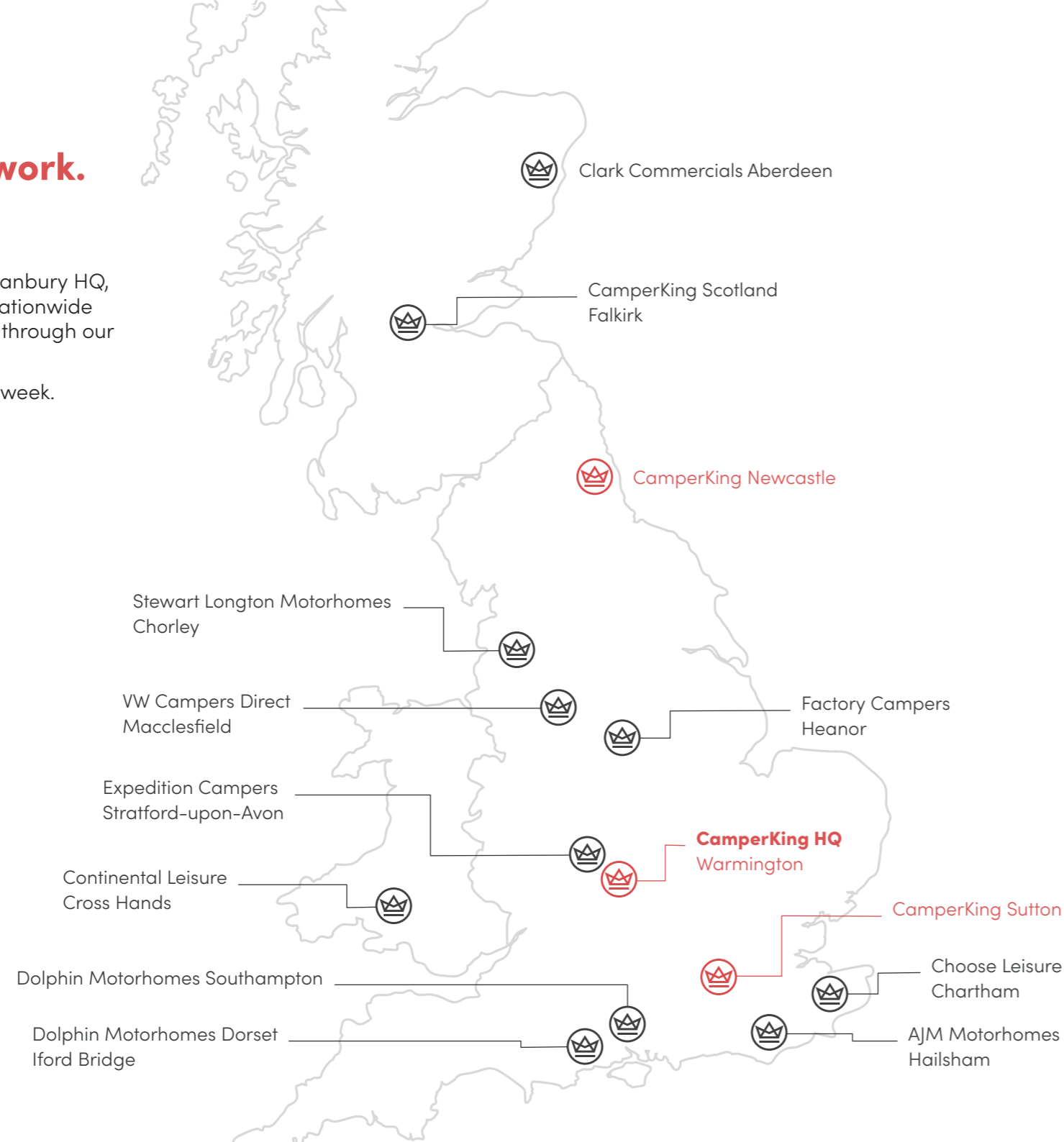

Club CamperKing

Club CamperKing is more than an owners' club – it's your invitation into a like-minded community built around freedom, adventure, and unforgettable memories on the road. You could be heading out for a spontaneous weekend escape or a well-planned road trip, Club CamperKing connects you with people who share your passion.

As a member, you'll enjoy access to exclusive events, road trips, behind-the-scenes experiences, and rewards designed just for CamperKing owners. Plus, you'll get 10% off in the CamperKing Shop, in-store and online, with savings on everything from awnings and cookware to beds, hobs, and van essentials.

It's free to join, easy to enjoy, and made to elevate your campervan lifestyle from the moment you hit the road.

Find out more at camperking.co.uk/club-camper-king

Supporting good causes.

At CamperKing we are proud to support numerous good causes, which includes past donations of £50,000 to Children in Need at CarFest.

The charity we currently support at CamperKing is very close to our hearts. Oscar's Paediatric Brain Tumour Charity is a small but dedicated organisation funding research into childhood brain tumours. Our fundraising efforts have included a team of our staff climbing Ben Nevis, as well as walking the Yorkshire Three Peaks.



Campervan jargon buster.

A quick guide to common campervan terms

4 Motion.

VW's four-wheel drive system for extra traction.

Ambient lighting.

Soft LED lighting inside the van.

Barn doors.

Twin rear doors that open outwards.

Berth.

The number of sleeping spaces.

Business pack.

Upgrade with parking sensors, cruise control & air con.

Campervan conversion.

A van transformed into a home on wheels.

CamperKing deluxe bed.

Our exclusive ISOFIX safety bedm.

Commerce / Plus / Pro.

VW T7 trim levels (basic to fully loaded).

Dealer.

An authorised CamperKing dealer.

Diesel heater.

Uses the van's fuel to heat the living space.

DSG.

VW's automatic gearbox with manual option.

Electric hook-up.

Campsite power connection.

Frontrunner roof system.

Modular roof rack for carrying gear.

Gas locker.

Safe, sealed storage for the gas bottle.

Habitation check.

Annual safety check on electrics, water & gas.

Highline.

High-spec VW trim with added comfort & tech.

Hire purchase.

Finance option with fixed monthly payments.

Jump seat.

Removable extra travel seat.

Kombi.

VW van with extra rear seats & cargo space.

Leisure battery.

Runs camper systems when the engine is off.

LWB / SWB.

Long or short wheelbase vehicle length.

Mobiframe bed.

Sliding bed system (Pursuit model).

Panel van.

Basic VW van used for most conversions.

Pop-top roof.

Elevating roof that adds headroom & sleeping space.

PMS.

Power management system for lights, water & battery levels.

Shuttle.

VW Transporter with three rows of seats (up to nine).

Startline.

VW's entry level Transporter trim.

Tailgate.

Single rear door hinged at the top.

Travelling seats.

Road legal passenger seats.

Two sone.

Custom paint with two different colours.

VW Assist.

Volkswagen breakdown & roadside cover.

VW Transporter.

Volkswagen's iconic van, built since 1949. All CamperKing conversions are crafted on the latest T6.1 and T7 models.



connect with the elements.



“Love being part of the CamperKing family”
Debbie Duckworth



CamperKing HQ

Banbury Road,
Warmington,
Banbury,
OX17 1JJ

01295 500025

sales@camperking.co.uk

CamperKing Newcastle

Queen Alexandra Road West,
North Shields,
Newcastle,
NE29 9AA

01918 409911

newcastlesales@camperking.co.uk

CamperKing Sutton

133 Stonecot Hill,
Sutton,
Surrey,
SM3 9HS

02081 785595

adminsurrey@camperking.co.uk

Follow us on social media for
the latest news and campervan
content.

AutoTrader

Highly Rated
FOR OUR
CUSTOMER
SERVICE 2023

